

# Quick setup guide

Radar sensor for continuous level measurement of liquids

## VEGAPULS 61

Foundation Fieldbus

Approval according to LPR radio standard



Document ID: 47107



**VEGA**

# Contents

- 1 For your safety ..... 3**
  - 1.1 Authorised personnel ..... 3
  - 1.2 Appropriate use ..... 3
  - 1.3 Warning about incorrect use ..... 3
  - 1.4 General safety instructions ..... 3
  - 1.5 EU conformity ..... 4
  - 1.6 NAMUR recommendations ..... 4
  - 1.7 Radio license for Europe ..... 4
  - 1.8 Environmental instructions ..... 5
- 2 Product description ..... 6**
  - 2.1 Configuration ..... 6
- 3 Mounting ..... 7**
  - 3.1 Collar or adapter flange ..... 7
  - 3.2 Mounting preparations, mounting strap ..... 7
  - 3.3 Mounting instructions ..... 8
- 4 Connecting to the bus system ..... 10**
  - 4.1 Connecting ..... 10
  - 4.2 Wiring plan, single chamber housing ..... 11
  - 4.3 Wiring plan, double chamber housing ..... 11
- 5 Set up with the display and adjustment module ..... 12**
  - 5.1 Insert display and adjustment module ..... 12
  - 5.2 Parameter adjustment ..... 13
  - 5.3 Menu overview ..... 16
- 6 Set up with smartphone/tablet, PC/notebook via Bluetooth ..... 18**
  - 6.1 Preparations ..... 18
  - 6.2 Connecting ..... 19
  - 6.3 Sensor parameter adjustment ..... 19
- 7 Supplement ..... 21**
  - 7.1 Technical data ..... 21



**Information:**

This quick setup guide enables quick setup and commissioning of your instrument.

You can find supplementary information in the corresponding, more detailed Operating Instructions Manual as well as the Safety Manual that comes with instruments with SIL qualification. These manuals are available on our homepage.

**Operating instructions VEGAPULS 61 - Foundation Fieldbus - Approval according to LPR radio standard; Document-ID 41716**  
 Editing status of the quick setup guide: 2021-06-10

# 1 For your safety

## 1.1 Authorised personnel

All operations described in this documentation must be carried out only by trained, qualified personnel authorised by the plant operator.

During work on and with the device, the required personal protective equipment must always be worn.

## 1.2 Appropriate use

VEGAPULS 61 is a sensor for continuous level measurement.

You can find detailed information about the area of application in chapter " *Product description*".

Operational reliability is ensured only if the instrument is properly used according to the specifications in the operating instructions manual as well as possible supplementary instructions.

## 1.3 Warning about incorrect use

Inappropriate or incorrect use of this product can give rise to application-specific hazards, e.g. vessel overflow through incorrect mounting or adjustment. Damage to property and persons or environmental contamination can result. Also, the protective characteristics of the instrument can be impaired.

## 1.4 General safety instructions

This is a state-of-the-art instrument complying with all prevailing regulations and directives. The instrument must only be operated in a technically flawless and reliable condition. The operator is responsible for the trouble-free operation of the instrument. When measuring aggressive or corrosive media that can cause a dangerous situation if the instrument malfunctions, the operator has to implement suitable measures to make sure the instrument is functioning properly.

The safety instructions in this operating instructions manual, the national installation standards as well as the valid safety regulations and accident prevention rules must be observed by the user.

For safety and warranty reasons, any invasive work on the device beyond that described in the operating instructions manual may be carried out only by personnel authorised by the manufacturer. Arbitrary conversions or modifications are explicitly forbidden. For safety reasons, only the accessory specified by the manufacturer must be used.

To avoid any danger, the safety approval markings and safety tips on the device must also be observed.

The low transmitting power of the radar sensor is far below the internationally approved limits. No health impairments are to be expected with intended use. The band range of the measuring frequency can be found in chapter " *Technical data*".

## 1.5 EU conformity

The device fulfils the legal requirements of the applicable EU directives. By affixing the CE marking, we confirm the conformity of the instrument with these directives.

The EU conformity declaration can be found on our homepage.

### Electromagnetic compatibility

Instruments in four-wire or Ex-d-ia version are designed for use in an industrial environment. Nevertheless, electromagnetic interference from electrical conductors and radiated emissions must be taken into account, as is usual with class A instruments according to EN 61326-1. If the instrument is used in a different environment, the electromagnetic compatibility to other instruments must be ensured by suitable measures.

## 1.6 NAMUR recommendations

NAMUR is the automation technology user association in the process industry in Germany. The published NAMUR recommendations are accepted as the standard in field instrumentation.

The device fulfils the requirements of the following NAMUR recommendations:

- NE 21 – Electromagnetic compatibility of equipment
- NE 53 – Compatibility of field devices and display/adjustment components
- NE 107 – Self-monitoring and diagnosis of field devices

For further information see [www.namur.de](http://www.namur.de).

## 1.7 Radio license for Europe

The instrument was tested according to the latest issue of the following harmonized standards:

- EN 302372 - Tank Level Probing Radar
- EN 302729 - Level Probing Radar

It is hence approved for use inside and outside closed vessels in countries of the EU.

Use is also approved in EFTA countries, provided the respective standards have been implemented.

For operation inside of closed vessels, points a to f in annex E of EN 302372 must be fulfilled.

For operation outside of closed vessels, the following conditions must be fulfilled:

- The installation must be carried out by trained qualified personnel
- The instrument must be stationary mounted and the antenna directed vertically downward
- The mounting location must be at least 4 km away from radio astronomy stations, unless special permission was granted by the responsible national approval authority

- When installed within 4 to 40 km of a radio astronomy station, the instrument must not be mounted higher than 15 m above the ground.

You can find a list of the respective radio astronomy stations in chapter " *Supplement*".

## 1.8 Environmental instructions

Protection of the environment is one of our most important duties. That is why we have introduced an environment management system with the goal of continuously improving company environmental protection. The environment management system is certified according to DIN EN ISO 14001.

Please help us fulfil this obligation by observing the environmental instructions in this manual:

- Chapter " *Packaging, transport and storage*"
- Chapter " *Disposal*"

## 2 Product description

### 2.1 Configuration

#### Type label

The type label contains the most important data for identification and use of the instrument:

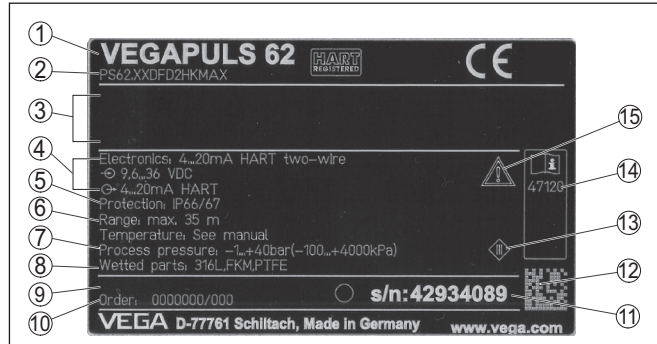

Fig. 1: Layout of the type label (example)

- 1 Instrument type
- 2 Product code
- 3 Approvals
- 4 Power supply and signal output, electronics
- 5 Protection rating
- 6 Measuring range
- 7 Process and ambient temperature, process pressure
- 8 Material wetted parts
- 9 Hardware and software version
- 10 Order number
- 11 Serial number of the instrument
- 12 Data matrix code for VEGA Tools app
- 13 Symbol of the device protection class
- 14 ID numbers, instrument documentation
- 15 Reminder to observe the instrument documentation

#### Serial number - Instrument search

The type label contains the serial number of the instrument. With it you can find the following instrument data on our homepage:

- Product code (HTML)
- Delivery date (HTML)
- Order-specific instrument features (HTML)
- Operating instructions and quick setup guide at the time of shipment (PDF)
- Order-specific sensor data for an electronics exchange (XML)
- Test certificate (PDF) - optional

Move to "[www.vega.com](http://www.vega.com)" and enter in the search field the serial number of your instrument.

Alternatively, you can access the data via your smartphone:

- Download the VEGA Tools app from the "Apple App Store" or the "Google Play Store"
- Scan the DataMatrix code on the type label of the instrument or
- Enter the serial number manually in the app

## 3 Mounting

### 3.1 Collar or adapter flange

For mounting the instrument on a nozzle, a combi compression flange for DN 80 (ASME 3" or JIS 80) is also available for retrofitting. Optionally, the instrument can be also equipped with an adapter flange from DN 100 (ASME 4" or JIS 100).

With the housing versions plastic, aluminium single chamber and stainless steel, the collar flange can be placed directly over the housing. With the aluminium double chamber housing, retroactive mounting in this way is not possible - the mounting type must be specified with the order.

You can find drawings of these mounting options in chapter "Dimensions".

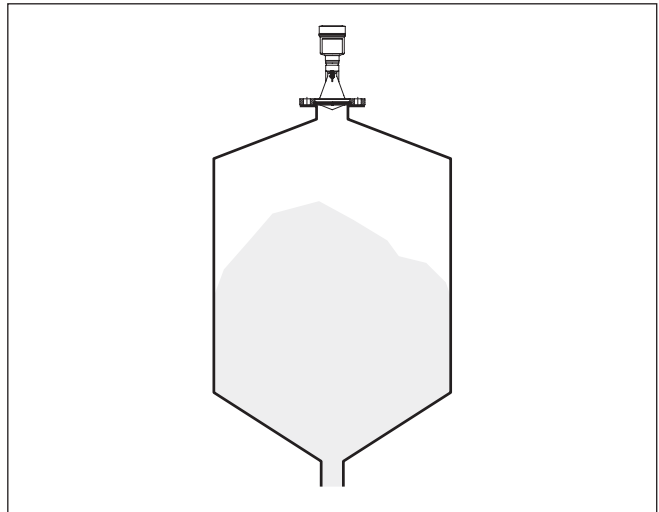

Fig. 2: Flange mounting of the radar sensor

### 3.2 Mounting preparations, mounting strap

The mounting strap enables simple mounting on the vessel wall or silo top. It is suitable for wall, ceiling or boom mounting. Especially in open vessels this is a very easy and effective way to align the sensor to the bulk solid surface.

The strap is supplied unassembled and must be screwed to the sensor before setup with three hexagon socket screws M5 x 10 and spring washers. Max. torque, see chapter "Technical data". Required tools: Allen wrench size 4.

There are two ways to screw the strap onto the sensor. Depending on the selected version, the sensors can be swivelled in the strap as follows:

- Single chamber housing

- Angle of inclination 180°, infinitely variable
- Angle of inclination in three steps 0°, 90° and 180°
- Double chamber housing
  - Angle of inclination 90°, infinitely variable
  - Angle of inclination in two steps 0° and 90°

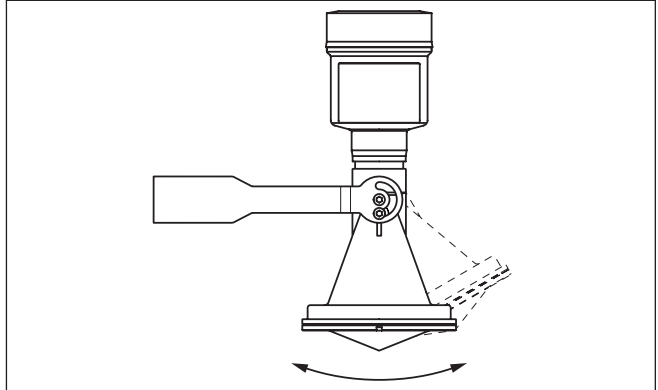

Fig. 3: Adjustment of the angle of inclination

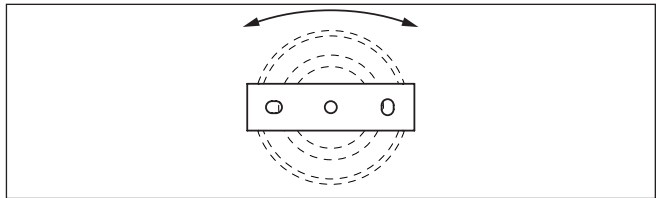

Fig. 4: Turning by fastening in the centre

### 3.3 Mounting instructions

#### Mounting

1. Distance from the vessel wall > 200 mm, the antenna should protrude > 10 mm into the vessel

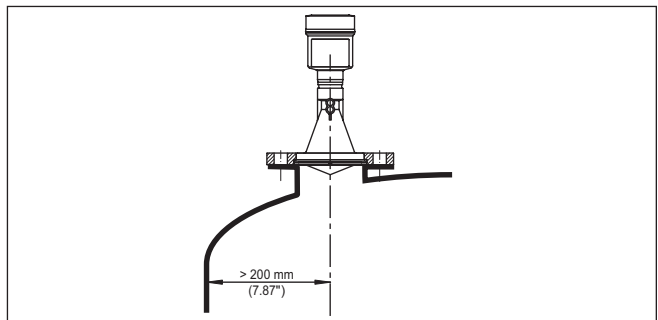

Fig. 5: Distance of the antenna to the vessel wall/vessel ceiling

2. Note min. socket diameter depending on the socket length



For further information see chapter " *Mounting*".

## 4 Connecting to the bus system

### 4.1 Connecting

#### Connection technology

The voltage supply and signal output are connected via the spring-loaded terminals in the housing.

Connection to the display and adjustment module or to the interface adapter is carried out via contact pins in the housing.



#### Information:

The terminal block is pluggable and can be removed from the electronics. To do this, lift the terminal block with a small screwdriver and pull it out. When reinserting the terminal block, you should hear it snap in.

#### Connection procedure

Proceed as follows:

1. Unscrew the housing lid
2. If a display and adjustment module is installed, remove it by turning it slightly to the left
3. Loosen compression nut of the cable gland and remove blind plug
4. Remove approx. 10 cm (4 in) of the cable mantle, strip approx. 1 cm (0.4 in) of insulation from the ends of the individual wires
5. Insert the cable into the sensor through the cable entry



Fig. 6: Connection steps 5 and 6

- 1 Single chamber housing
- 2 Double chamber housing

6. Insert the wire ends into the terminals according to the wiring plan



#### Note:

Solid cores as well as flexible cores with wire end sleeves are inserted directly into the terminal openings. In case of flexible cores without end sleeves, press the terminal from above with a small screwdriver, the terminal opening is then free. When the screwdriver is released, the terminal closes again.

7. Check the hold of the wires in the terminals by lightly pulling on them
8. Connect the shielding to the internal ground terminal, connect the external ground terminal to potential equalisation

9. Tighten the compression nut of the cable entry gland. The seal ring must completely encircle the cable
  10. Reinsert the display and adjustment module, if one was installed
  11. Screw the housing lid back on
- The electrical connection is finished.

### 4.2 Wiring plan, single chamber housing

#### Electronics and connection compartment

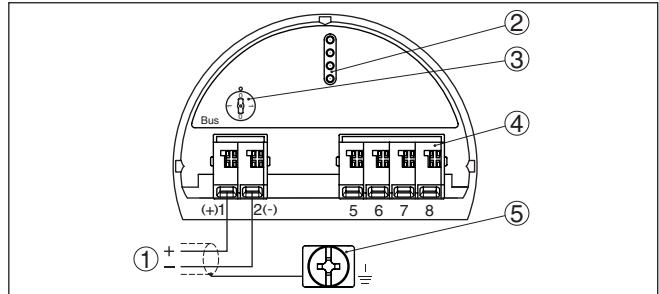

Fig. 7: Electronics and connection compartment - single chamber housing

- 1 Voltage supply, signal output
- 2 Contact pins for the display and adjustment module or interface adapter
- 3 Simulation switch ("1" = mode for simulation release)
- 4 For external display and adjustment unit
- 5 Ground terminal for connection of the cable screening

### 4.3 Wiring plan, double chamber housing

#### Connection compartment

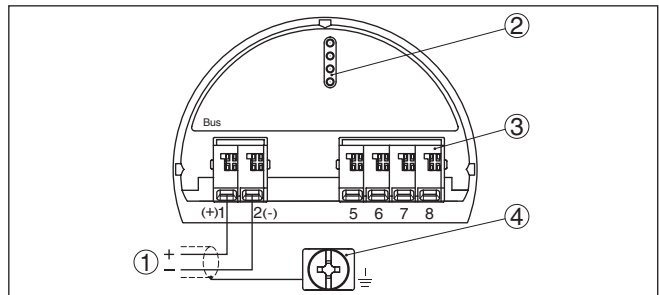

Fig. 8: Connection compartment - double chamber housing

- 1 Voltage supply, signal output
- 2 For display and adjustment module or interface adapter
- 3 For external display and adjustment unit
- 4 Ground terminal for connection of the cable screening



#### Information:

Parallel use of an external display and adjustment unit and a display and adjustment module in the connection compartment is not supported.

## 5 Set up with the display and adjustment module

### 5.1 Insert display and adjustment module

The display and adjustment module can be inserted into the sensor and removed again at any time. You can choose any one of four different positions - each displaced by 90°. It is not necessary to interrupt the power supply.

Proceed as follows:

1. Unscrew the housing lid
2. Place the display and adjustment module on the electronics in the desired position and turn it to the right until it snaps in.
3. Screw housing lid with inspection window tightly back on

Disassembly is carried out in reverse order.

The display and adjustment module is powered by the sensor, an additional connection is not necessary.



Fig. 9: Installing the display and adjustment module in the electronics compartment of the single chamber housing

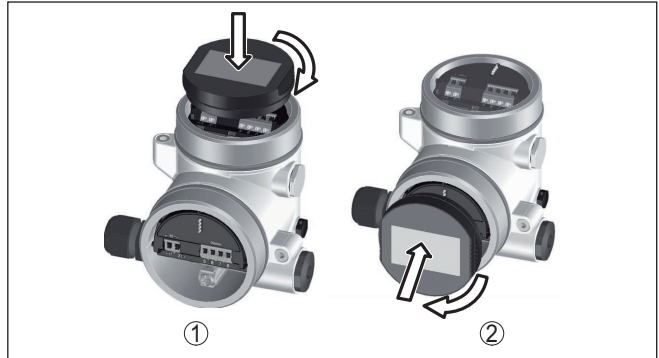

Fig. 10: Installing the display and adjustment module in the double chamber housing

- 1 In the electronics compartment
- 2 In the connection compartment



**Note:**

If you intend to retrofit the instrument with a display and adjustment module for continuous measured value indication, a higher lid with an inspection glass is required.

## 5.2 Parameter adjustment

### Set parameters

1. Go to the menu "Setup" via the display and adjustment module.

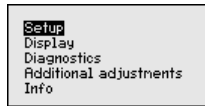

2. In the menu item "Medium" you select the medium of your application, for example "Aqueous solution".

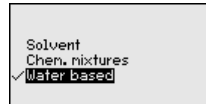
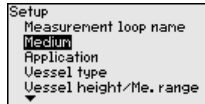

3. Select in the menu item "Application" the vessel, the application and the vessel form, for example, storage tank.

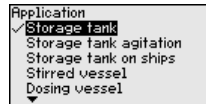
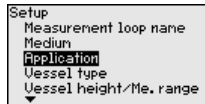

4. Carry out the adjustment in the menu items "Min. adjustment" and "Max. adjustment".

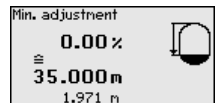
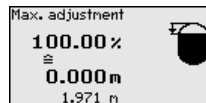
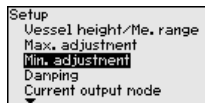

**Parameterization example** The radar sensor measures the distance from the sensor to the medium surface. For indication of the real level, an allocation of the measured distance to the percentage height must be carried out.

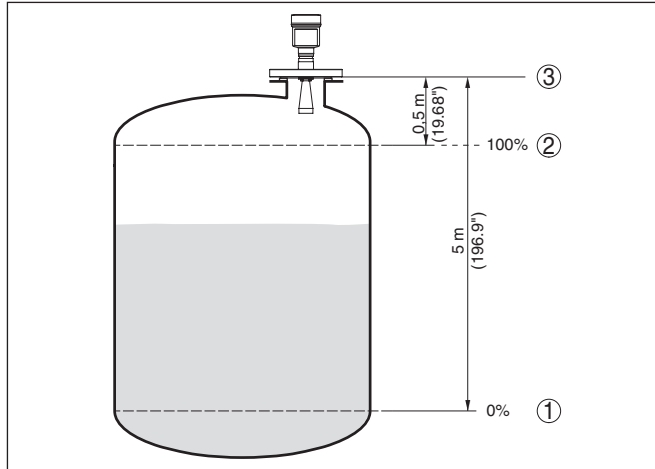

Fig. 11: Parameterisation example, Min./max. adjustment

- 1 Min. level = max. measuring distance
- 2 Max. level = min. measuring distance
- 3 Reference plane

For this adjustment, the distance is entered when the vessel is full and nearly empty. If these values are not known, an adjustment with other distances, for example, 10 % and 90 % is also possible. Starting point for these distance specifications is always the seal surface of the thread or flange.

### Diagnostics - Echo curve memory

The function "Echo curve memory" makes it possible to save the echo curve at the time of setup. This is generally recommended, and it is absolutely necessary if you want to use the Asset Management functions. If possible, the curve should be saved with a low level in the vessel.

With the adjustment software PACTware and a PC, a high resolution echo curve can be displayed and used to recognize signal changes during operation. In addition, the echo curve of setup can be displayed in the echo curve window and compared with the current echo curve.

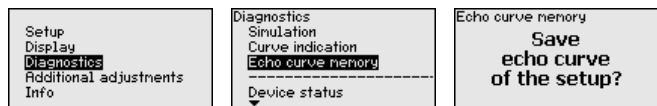

### Additional settings - False signal suppression

The following circumstances cause interfering reflections and can influence the measurement:

- High mounting nozzles
- Vessel internals such as struts

- Agitators
- Buildup or welded joints on vessel walls



**Note:**

A false signal suppression detects, marks and saves these false signals to ensure that they are ignored in the level measurement.

This should be done with the lowest possible level so that all potential interfering reflections can be detected.

Proceed as follows:

1. Select with **[->]** the menu item " *False signal suppression*" and confirm with **[OK]**.

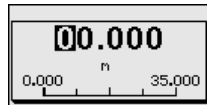
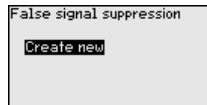
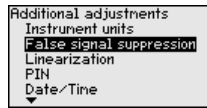

2. Confirm 3-times with **[OK]** and enter the actual distance from the sensor to the product surface.
3. All interfering signals in this range are detected by the sensor and stored after being confirmed with **[OK]**.



**Note:**

Check the distance to the medium surface, because if an incorrect (too large) value is entered, the existing level will be saved as a false signal. The level would then no longer be detectable in this area.

If a false signal suppression has already been saved in the sensor, the following menu window appears when selecting " *False signal suppression*":

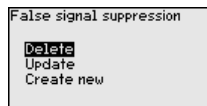

**Delete:** An already created false signal suppression will be completely deleted. This is useful if the saved false signal suppression no longer matches the metrological conditions in the vessel.

**Extend:** is used to extend an already created false signal suppression. This is useful if a false signal suppression was carried out with too high a level and not all false signals could be detected. When selecting " *Extend*", the distance to the medium surface of the created false signal suppression is displayed. This value can now be changed and the false signal suppression can be extended to this range.

### 5.3 Menu overview

#### Setup

Menu item	Parameter	Default setting
Measurement loop name		Sensor
Medium		Liquid Water based
Application		Storage tank
Vessel shape	Vessel top	Dished form
	Vessel bottom	Dished form
Vessel height/ Measuring range		35 m
Max. adjustment		0,000 m(d) 100.00 %
Min. adjustment		35 m 0.00 %
Damping	Integration time	0.0 s
Current output mode	Output characteristics	4 ... 20 mA
	Failure mode	≤ 3.6 mA
Current output - Min./Max.	Min. current	3.8 mA
	Max. current	20.5 mA
Lock adjustment		Released

#### Display

Menu item	Default setting
Language	Order-specific
Displayed value	Filling height in %
Backlight	Switched on

#### Diagnostics

Menu item	Parameter	Default setting
Device status		-
Peak value indicator	Distance	-
Electronics temperature	Temperature	-
Measurement reliability		-
Simulation		Percent
Curve display	Echo curve	-
	False signal suppression	-



Menu item	Parameter	Default setting
Echo curve memory		-

## Additional adjustments

Menu item	Default setting
Instrument units	Distance in m Temperature in °C
Unit SV2	Distance in m
False signal suppression	-
Linearisation	Linear
PIN	-
Date/Time	Actual date/Actual time
Reset	-
HART mode	Address 0
Copy instrument settings	-

## Info

Menu item	Parameter
Device name	VEGAPULS 6.
Instrument version	Hardware and software version
Date of manufacture	Date
Device ID	
Instrument features	Order-specific characteristics

## 6 Set up with smartphone/tablet, PC/ notebook via Bluetooth

### 6.1 Preparations

#### Activate Bluetooth

Make sure that the Bluetooth function of the display and adjustment module is activated. For this, the switch on the bottom side must be set to "On".

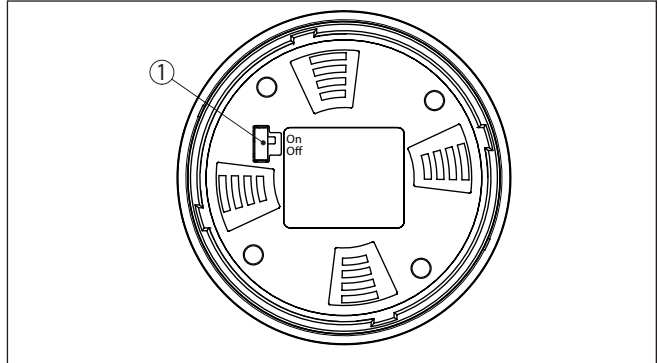

Fig. 12: Activate Bluetooth

1 Switch

On = Bluetooth active

Off = Bluetooth not active

#### Change sensor PIN

The security concept of Bluetooth operation absolutely requires that the default setting of the sensor PIN be changed. This prevents unauthorized access to the sensor.

The default setting of the sensor PIN is "0000". First of all you have to change the sensor PIN in the adjustment menu of the sensor, e.g. to "1111":

1. In the adjustment menu, go to "Additional adjustments", "PIN"



#### Note:

The menu item "PIN" is only displayed if in the menu "Setup", "Lock/Unlock adjustment" the adjustment is released.

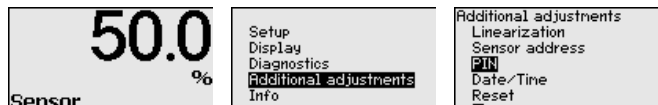

2. Change sensor PIN

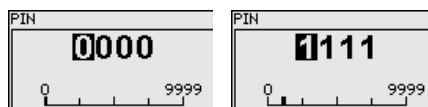

**Note:**

Bluetooth access can only be established if the current sensor PIN differs from the default setting "0000". It is possible both when the PIN is deactivated and when it is activated (adjustment menu "Setup", "Lock/Unlock adjustment").

## 6.2 Connecting

### Preparations

**Smartphone/Tablet**

Start the adjustment app and select the function "Setup". The smartphone/tablet searches automatically for Bluetooth-capable instruments in the area.

**PC/Notebook**

Start PACTware and the VEGA project assistant. Select the device search via Bluetooth and start the search function. The device automatically searches for Bluetooth-capable devices in the vicinity.

### Connecting

The message " *Instrument search running*" is displayed. All devices found are listed in the operating window. The search is automatically continued continuously.

Select in the device list the requested device. The message " *Connecting*" is displayed.

### Authenticate

For the first connection, the operating device and the sensor must authenticate each other. After successful authentication, the next connection functions without authentication.

For authentication, enter in the next menu window the 4-digit sensor PIN.

## 6.3 Sensor parameter adjustment

The sensor parameterization is carried out via the adjustment app on the smartphone/tablet or the DTM on the PC/notebook.

## App view

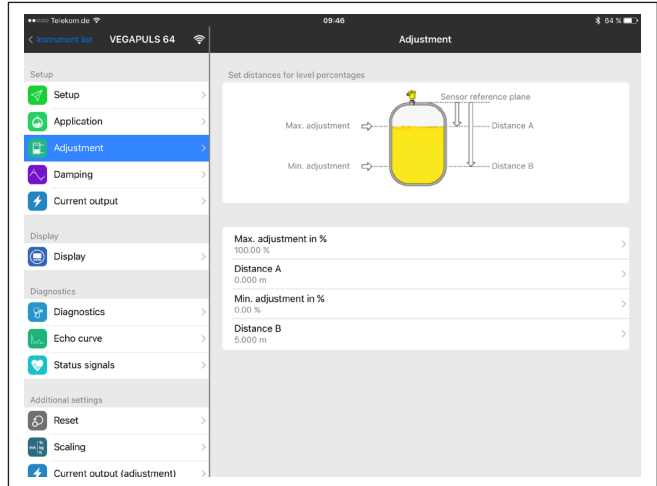

Fig. 13: Example of an app view - Setup sensor adjustment

## 7 Supplement

### 7.1 Technical data

#### Note for approved instruments

The technical data in the respective safety instructions which are included in delivery are valid for approved instruments (e.g. with Ex approval). These data can differ from the data listed herein, for example regarding the process conditions or the voltage supply.

All approval documents can be downloaded from our homepage.

#### Electromechanical data - version IP66/IP67 and IP66/IP68 (0.2 bar)

Options of the cable entry

- Cable entry M20 x 1.5; ½ NPT
- Cable gland M20 x 1.5; ½ NPT (cable ø see below table)
- Blind plug M20 x 1.5; ½ NPT
- Closing cap ½ NPT

Material cable gland	Material seal insert	Cable diameter				
		4.5 ... 8.5 mm	5 ... 9 mm	6 ... 12 mm	7 ... 12 mm	10 ... 14 mm
PA	NBR	-	●	●	-	●
Brass, nickel-plated	NBR	●	●	●	-	-
Stainless steel	NBR	-	●	●	-	●

Wire cross-section (spring-loaded terminals)

- Massive wire, stranded wire 0.2 ... 2.5 mm<sup>2</sup> (AWG 24 ... 14)
- Stranded wire with end sleeve 0.2 ... 1.5 mm<sup>2</sup> (AWG 24 ... 16)

#### Voltage supply

- Operating voltage U<sub>B</sub> 9 ... 32 V DC
- Operating voltage U<sub>B</sub> with lighting switched on 13.5 ... 32 V DC
- Power supply by/max. number of sensors
  - Fieldbus max. 32

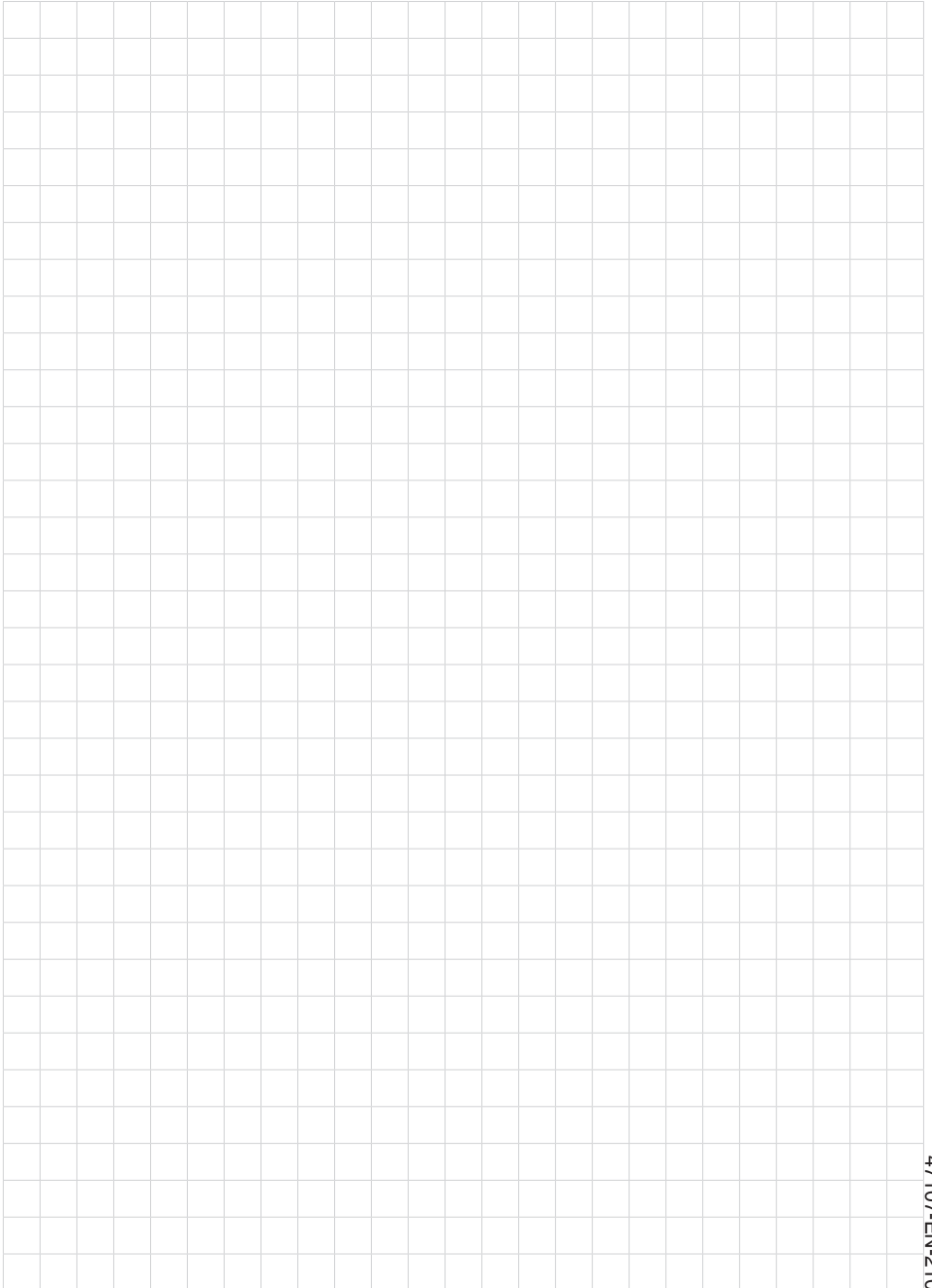



Printing date:

**VEGA**

All statements concerning scope of delivery, application, practical use and operating conditions of the sensors and processing systems correspond to the information available at the time of printing.

Subject to change without prior notice

© VEGA Grieshaber KG, Schiltach/Germany 2021



47107-EN-210621

VEGA Grieshaber KG  
Am Hohenstein 113  
77761 Schiltach  
Germany

Phone +49 7836 50-0  
E-mail: [info.de@vega.com](mailto:info.de@vega.com)  
[www.vega.com](http://www.vega.com)